



DAX-AB-1379



SOLID SURFACE SINKS SERIES



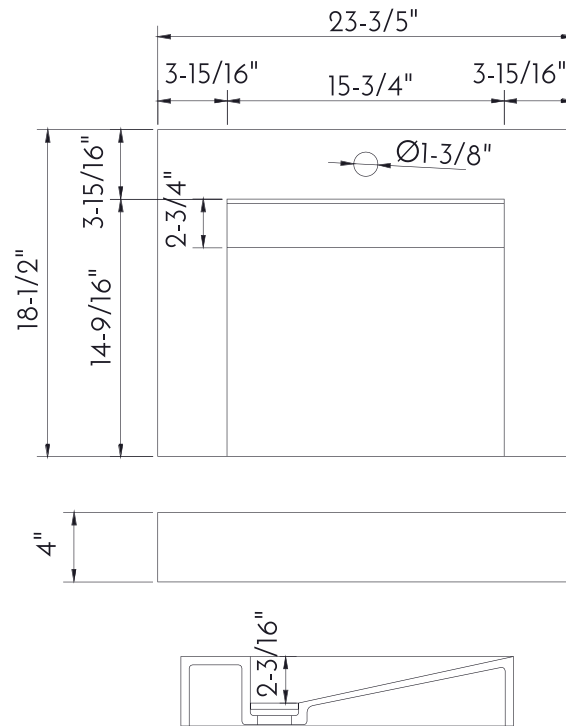

FEATURES

- Solid surface material
- White matte finish
- Vessel installation
- Size W 23-3/5" x H 18-1/2" x D 4"





01

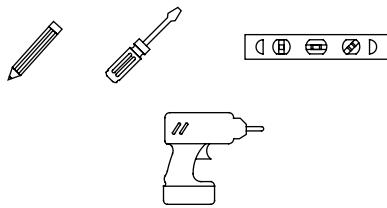

Tools: drill, level, pencil, screwdriver etc.
Accessories: mounting brackets and wall hung screws.

02

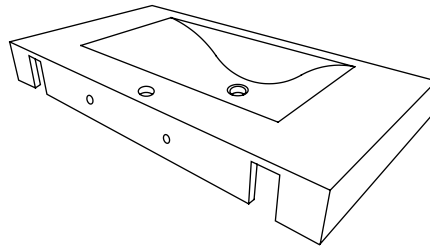

KKR can help clients open the bracket and screw holes in advance.

03

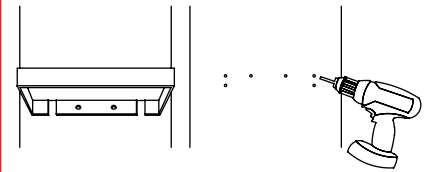

Determine the height you want. Place basin against the wall. Use a level to make sure both sides are level. Mark location and drill on wall for mounting holes.

04

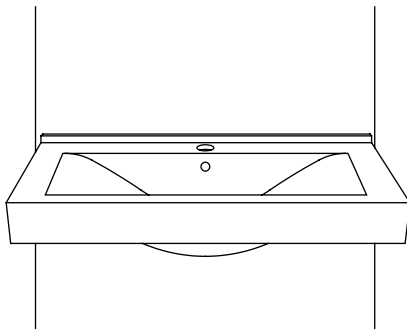

Secure the sink to the wall with the mounting brackets and screws. After inserting the first fastener, verify that the sink is level. When the sink is properly aligned insert the remaining fasteners.

05

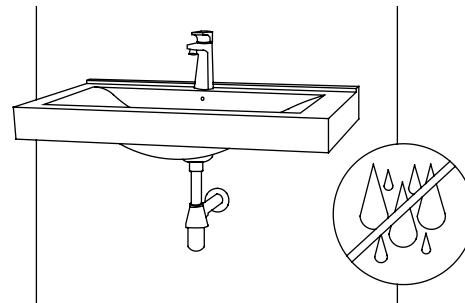

Connect all supply tubes to the faucet. Turn on the water supply to check for any leaking from the water supply lines or sink.

For parts or sale requirements please contact our customer service department:

 CS@daxib.com

 1 888 685 8236